

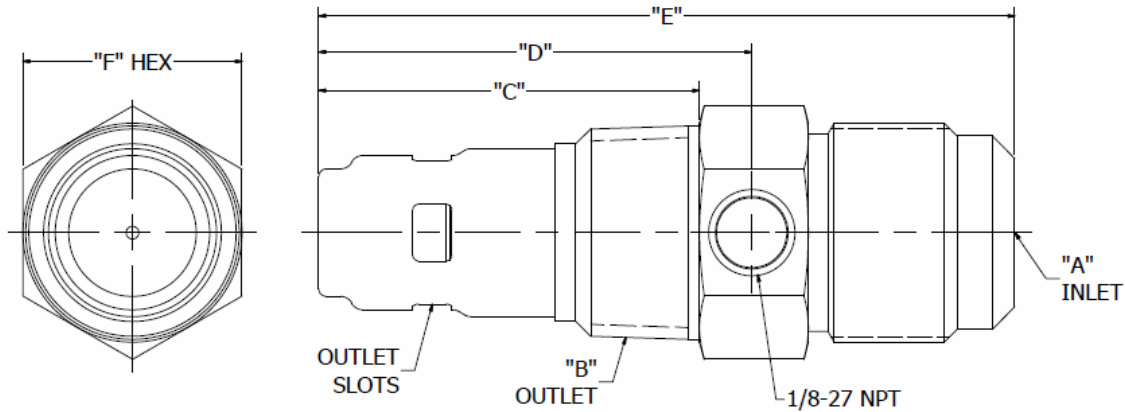

**In-Tank Check Valve
Model: CTF-Series**



Max Operating Pressure: 500 psig

Operating Temperature Range: -65° to 450°F

Available Flow Capacities: 20 to 30 SCFM

Available Inlet Connection Sizes: 1/2" to 3/4" (-8 to -12)

Inlet Connection Type: 45° Flare Tube

Available Outlet Connection Sizes: 1/2" to 3/4" (-8 to -12)

Outlet Connection Type: Male NPT

Materials of Construction:

Body: Brass

Valve Housing: Plated Steel

Seal: Reinforced PTFE

Spring: 302 Stainless Steel

MODEL	"A" (TUBE)	"B" (NPT)	"C" (in)	"D" (in)	"E" (in)	"F" (in)	RATED FLOW (SCFM @ 100 psig)	FLOW FACTOR (Cv)
CTF1212	1/2"	1/2"	1.67	1.92	2.88	7/8"	20	2.3
CTF5834	5/8"	3/4"	1.85	2.10	3.25	1-1/16"	30	3.9
CTF3434	3/4"	3/4"	1.85	2.10	3.37	1-1/16"	30	3.9



CONRADER

Ordering Information

CTF		12	12	-	P1	-	NP	-	PLUG	-	SST
Inlet Connection Size		Outlet Connection Size		Additional Side Port		Plating Option		Plugged Side Ports		Thread Sealant	
				Option	Code	Option	Code	Option	Code	Option	Code
				None	(Blank)	None	(Blank)	Not Plugged	(Blank)	None	(Blank)
				1/8" NPT	P1	Nickel Plated	NP	Plugged	(Plug)	White	SST
				1/4" NPT	P2						

Options

1. Inlet Connection Size: The available sizes are 1/2" to 3/4".
2. Outlet Connection Size: The available sizes are 1/2" to 3/4".
 - Note: Not all inlet/outlet size combinations are available. Call or email to check for availability.
3. Additional Side Port
 - a. 1/8" – Additional 1/8" female NPT side port 180° from existing port.
 - b. 1/4" – Additional 1/4" female NPT side port 180° from existing port.
4. Plating Option
 - a. None
 - b. Nickel Plated – Electroless Nickel Plated Brass
5. Plugged Side Ports
 - a. Not Plugged – Side ports are not plugged.
 - b. Plugged – Side ports are plugged with removable threaded plated steel plugs.
6. Thread Sealant
 - a. White colored thread sealant
 - b. Rust colored thread sealant

Examples:

1. A CTF check valve with a 5/8" flare inlet connection and 3/4" NPT outlet connection with the side port plugged is **CTF5834-PLUG**.
2. A CTF nickel plated check valve with 1/2" tube inlet connection and 1/2" NPT outlet connection with an additional 1/4" NPT side port is **CTF1212-P2-NP**.